

Specification of Thermoelectric Module

TEC1-01703

Description

The 17 couples, 15mmx15mm size module is a single stage module which is designed for cooling and heating up to 100°C applications. If higher operation or processing temperature is required, please specify, we can design and manufacture the custom made module according to your special requirements.

Features

- No moving parts, no noise, and solid-state
- Compact structure, small in size, light in weight
- Environmental friendly
- RoHS compliant
- Precise temperature control
- Exceptionally reliable in quality, high performance

Application

- Food and beverage service refrigerator
- Portable cooler box for cars
- Liquid cooling
- Temperature stabilizer
- CPU cooler and scientific instrument
- Photonic and medical systems

Performance Specification Sheet

Th(°C)	27	50	Hot side temperature at environment: dry air, N ₂
DT _{max} (°C)	68	76	Temperature Difference between cold and hot side of the module when cooling capacity is zero at cold side
U _{max} (Voltage)	2.1	2.3	Voltage applied to the module at DT _{max}
I _{max} (amps)	4.4	4.4	DC current through the modules at DT _{max}
Q _{Cmax} (Watts)	5.7	6.3	Cooling capacity at cold side of the module under DT=0°C
AC resistance(ohms)	0.3~0.5	0.33~0.55	The module resistance is tested under AC

Geometric Characteristics Dimensions in millimeters

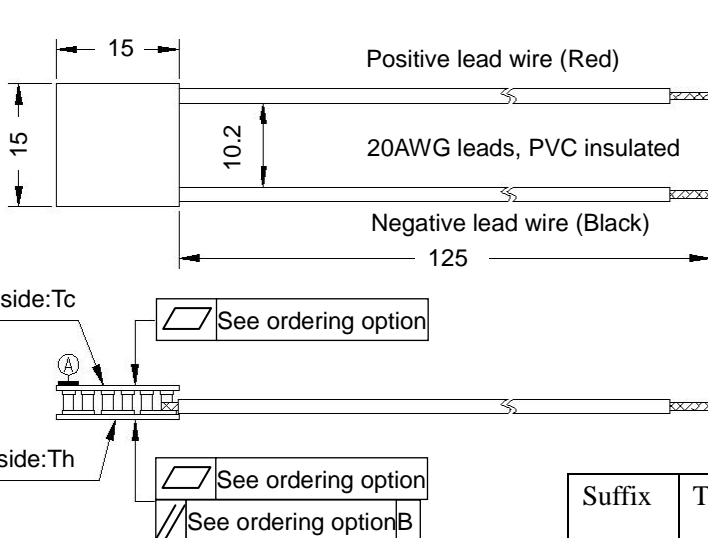

Sealing Option

Suffix	Sealant
NS	No sealing
SS	Silicone sealant
EPS	Epoxy
OS	Customer specify sealing other than above

Ordering Option

Suffix	Thickness (mm)	Flatness/Parallelism (mm)	Lead wire length(mm) Standard/Optional length
TF	0: 4.2±0.1	0: 0.020/0.020	125±1/Specify
TF	1: 4.2±0.05	1: 0.015/0.015	125±1/Specify
TF	2: 4.2±0.03	2: 0.010/0.010	125±1/Specify
Eg. TF01: Thickness 4.2±0.1(mm) and Flatness 0.015/0.015(mm)			

Additional

Ceramic material: Alumina (Al₂O₃, white 96%)

Solder tinning: Bismuth Tin (BiSn) M.P. 138°C

Creative technology with fine manufacturing processes provides you the reliable and quality products.

Tel: +86-791-88198288 Fax: +86-791-88198308 Email: info@thermonamic.com Web Site: www.thermonamic.com

Specification of Thermoelectric Module

TEC1-01703

Performance Curves at $T_h=27^\circ\text{C}$

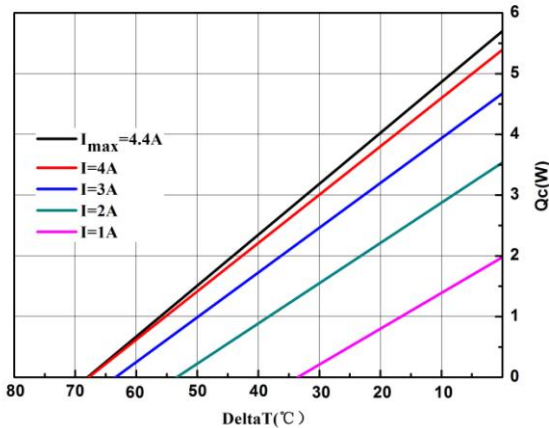

The chart for Q_c Vs ΔT under various currents

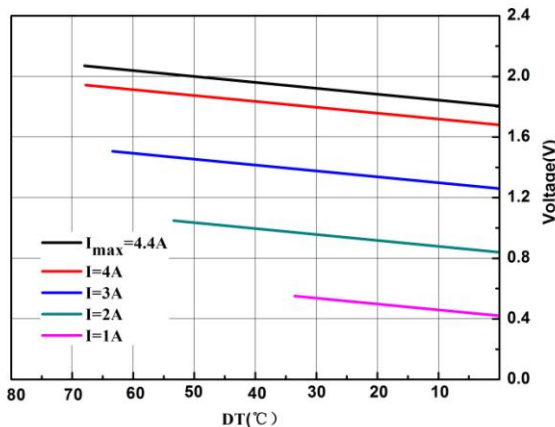

The chart for Voltage Vs ΔT under various currents

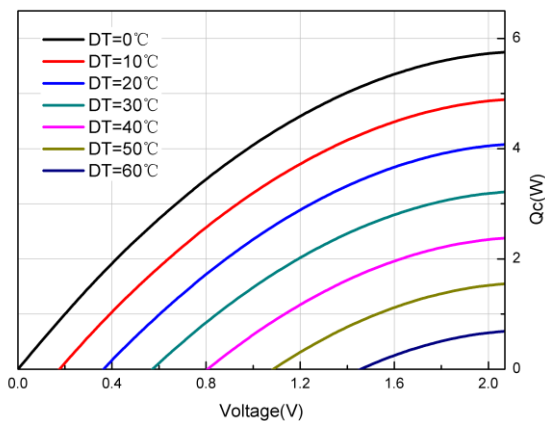

The chart for Q_c Vs Voltage under various ΔT

Performance Curves at $T_h=50^\circ\text{C}$

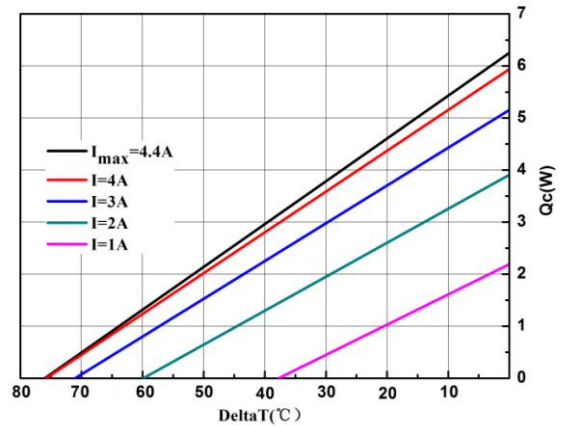

The chart for Q_c Vs ΔT under various currents

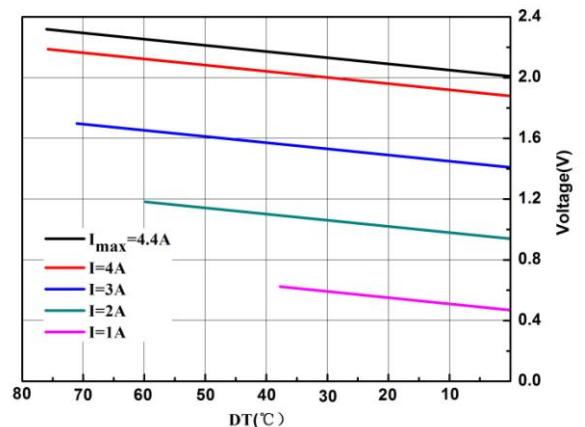

The chart for Voltage Vs ΔT under various currents

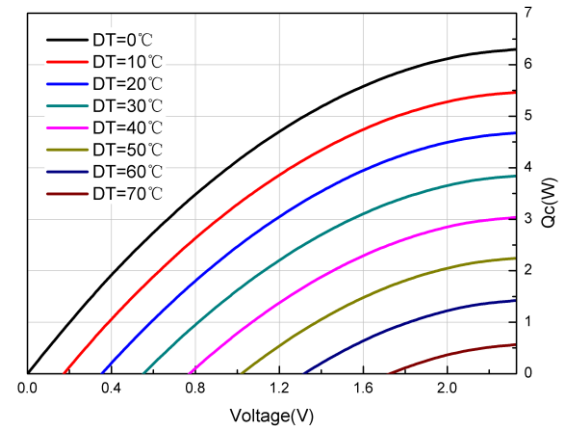

The chart for Q_c Vs Voltage under various ΔT

Operation Cautions

- Cold side of the module stucked on the object being cooled
- Hot side of the module mounted on a heat radiator
- Work under DC
- Operation below I_{max} or V_{max}
- Operation or storage module below 100°C